

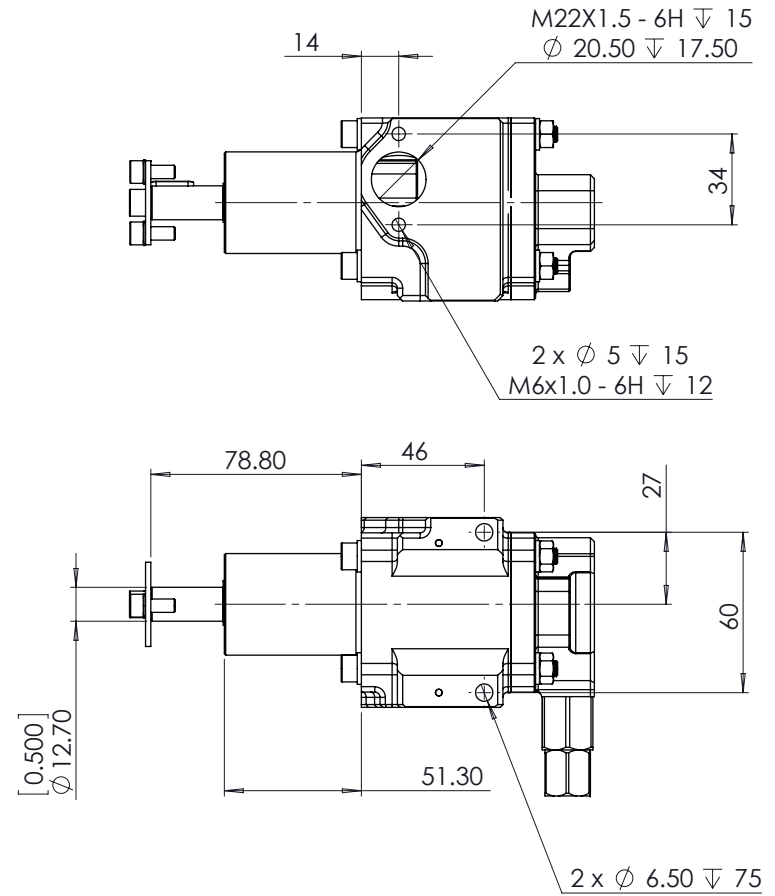

NOTES:

1. DISPLACEMENT PER REVERLUTION PER STAGE = 20.1 CC/REV
2. DISPLACEMENT AT 1000 RPM = 20.1 LT/MIN
3. PRV CRACKING PRESSURE:-  
 MINIMUM = 2.9 BAR (42 PSI)  
 MAXIMUM = 8.27 BAR (120PSI)
4. FOR EACH FULL TURN OF THE ADJUSTER THE CRACKING PRESSURE WILL INCREASE/DECREASE BY 0.25 BAR (3.6 PSI)

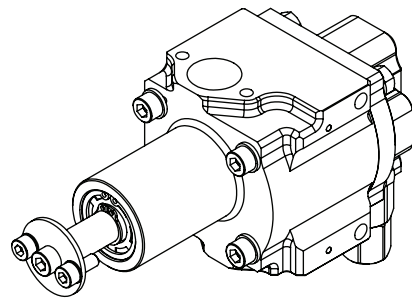
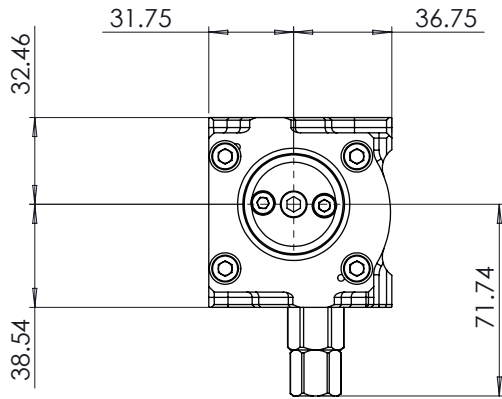
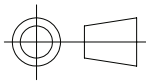

 COPYRIGHT (c) 2013 AT POWER LTD UNIT 9, CHESTNUT DRIVE, WYMONDHAM, NORFOLK, UK, NR18 9SB	 THIRD ANGLE PROJECTION	MATERIAL	SEE COMPONENT PARTS	
		FINISH	SEE COMPONENT PARTS	
UNLESS OTHERWISE STATED: DIMENSIONS IN MILLIMETRES TOLERANCES: LINEAR ± 0.1 ANGULAR ± 0.5° SURFACE FINISH ∇ = ∇ DRAWING STANDARDS TO ATQS 6003 DATE FORMAT: DD/MM/YY  THIS DESIGN IS THE PROPERTY OF AT POWER THROTTLES LTD AND MUST NOT BE REPRODUCED OR COMMUNICATED WITHOUT AUTHORITY	SCALE	1:2	WEIGHT	1.2 kg
	DRAWN-	S.HOW		
	DATE -	17/06/19		
	CHECKED -	S.HOW		
	APPROVED -	A.CLIFTON		
	CAD PLOT DO NOT SCALE	DRAWING TITLE		1 STAGE CORDIS-PRESSURE PUMP-LONG NOSE-20.1 Lt
		DRAWING NUMBER		104-103-00078
				SHEET 2 OF 2 A3